



Beyond 5G/6G Networks with Cloud Agility, Elasticity, and Resiliency

June 2023

Masahisa Kawashima
IOWN Development Office, NTT

Arising Issues

5G & MEC **alone** would **not** be able to **sustainably** support cyber-physical applications

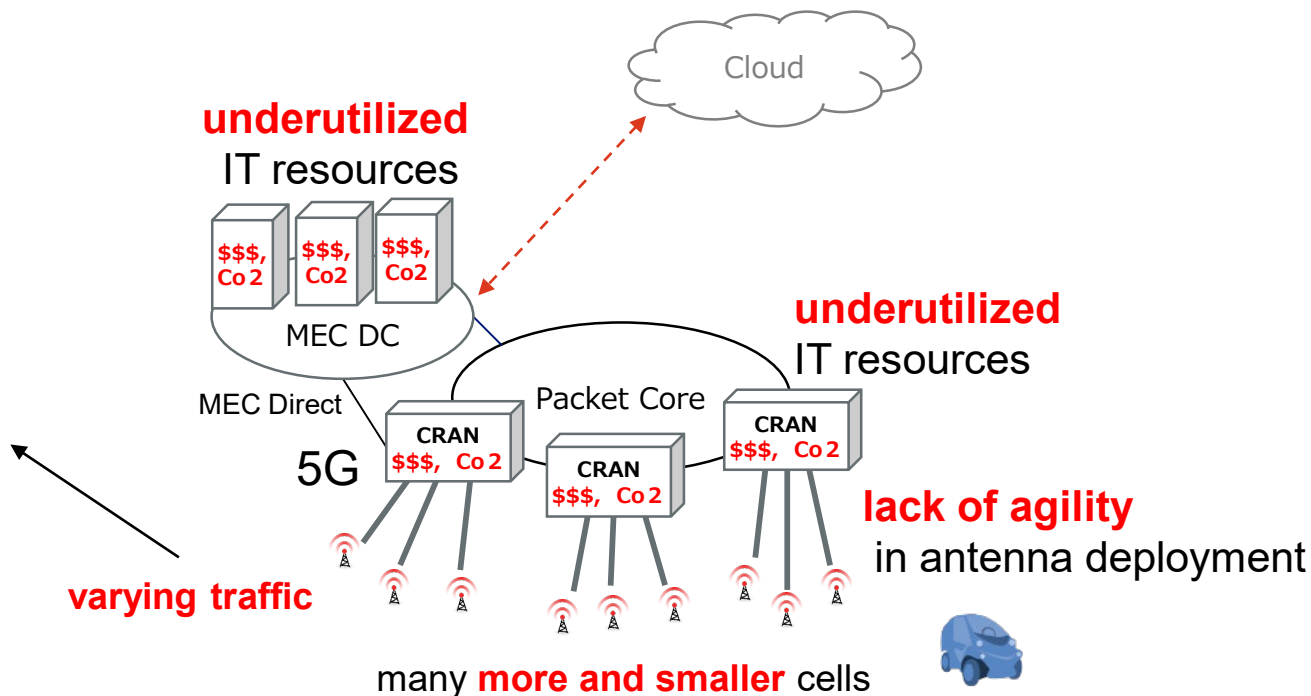
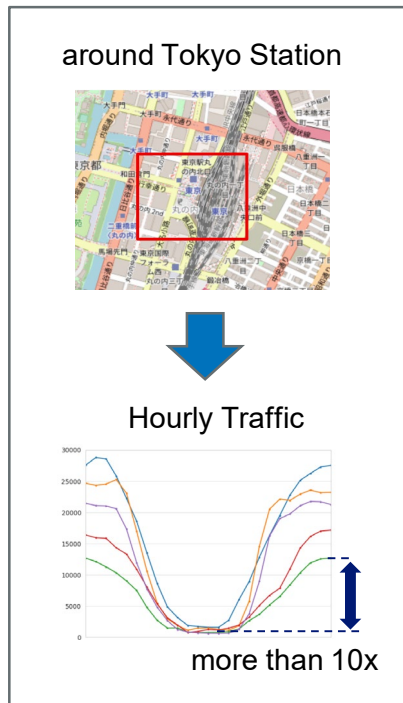

Solution

Beyond 5G/6G Vision (Proposal)

Beyond 5G/6G Networks with Cloud Agility, Elasticity, and Resiliency

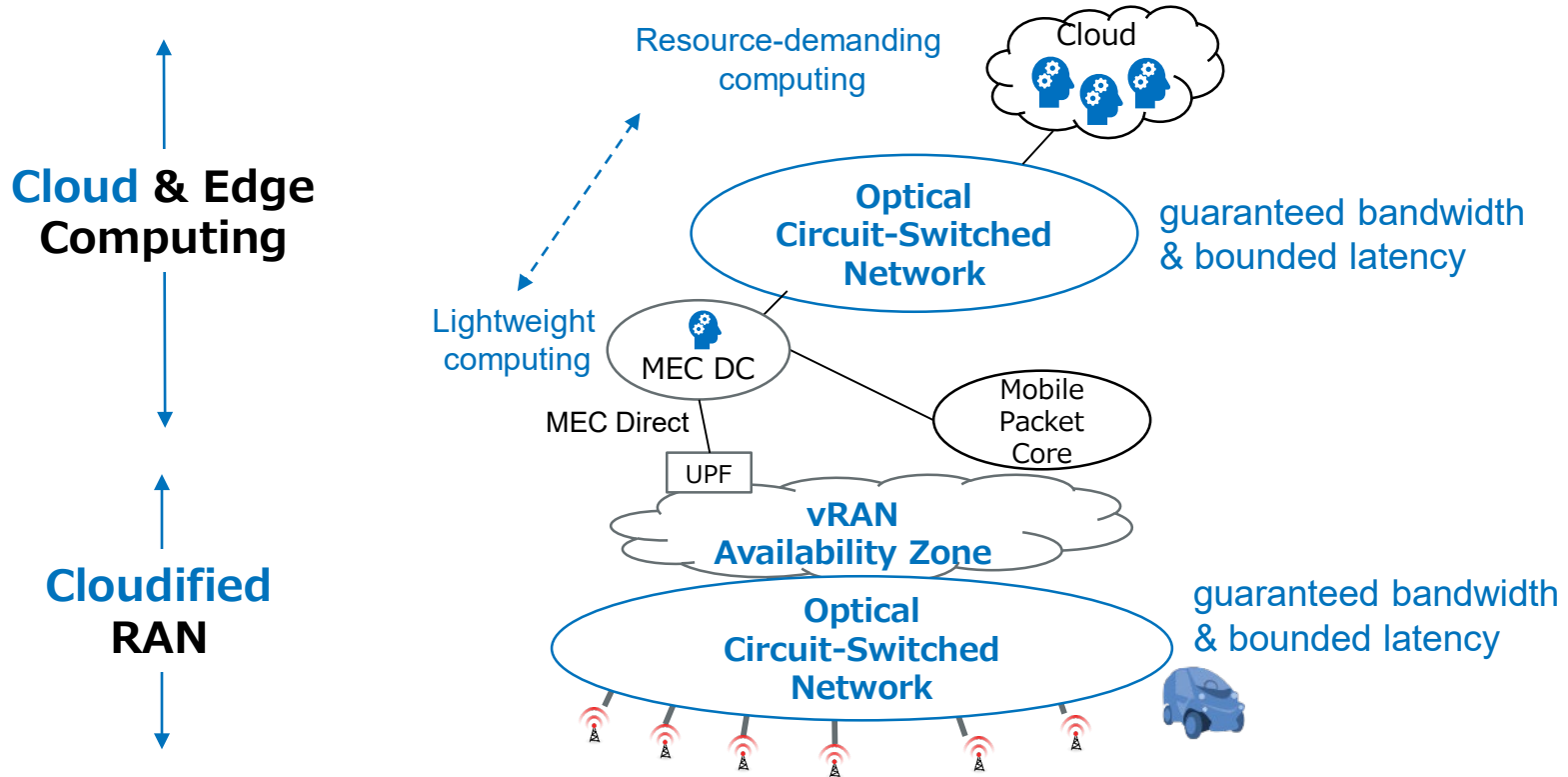

IOWN Global Forum Open APN

Like travelling on a **direct train**. **No more grasshopping.**

Connect two sites with guaranteed bandwidth and bounded latency, 0.5msec/100km

Today's Network

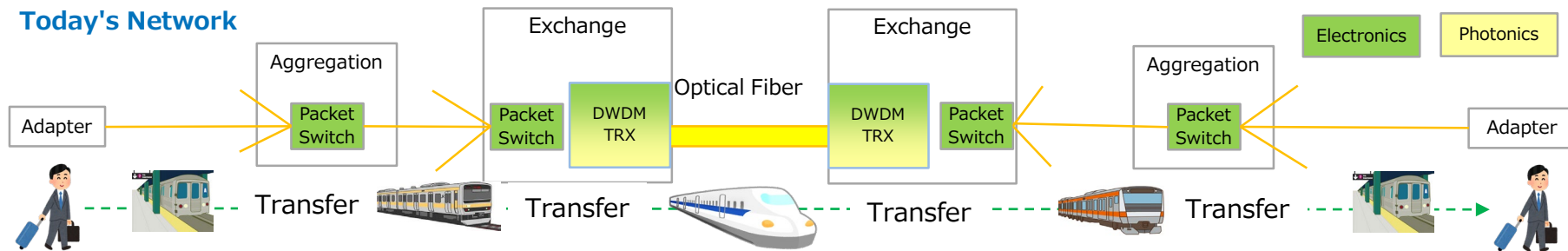

All Photonics Network (APN)

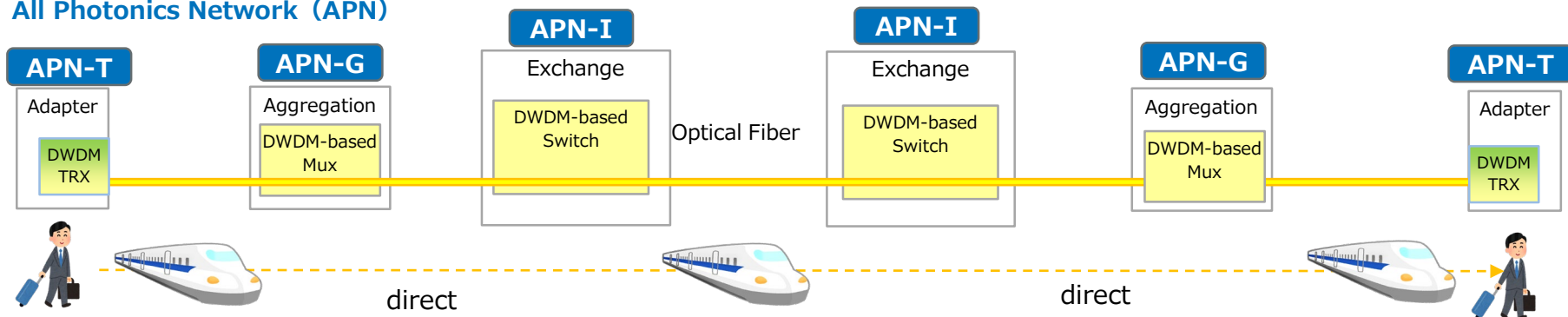

abc

defined by IOWN Global Forum Open APN

Summary

Arising Issues with 5G

- **Underutilized** IT resources
- **Lack of Agility**

Proposed Solution

- Marriage between **Radio and Optical** with IOWN APN
 - **Cloudified** RAN with IOWN APN
 - **Cloud-and-Edge** Computing with IOWN APN



Beyond 5G/6G Networks with **Cloud Agility, Elasticity, and Resiliency**

IOWN Global Forum will hold the next all member meeting in Munich, Germany on September 5-7.

Supplementary Slides

Technology Stack for IOWN Computing and Networking

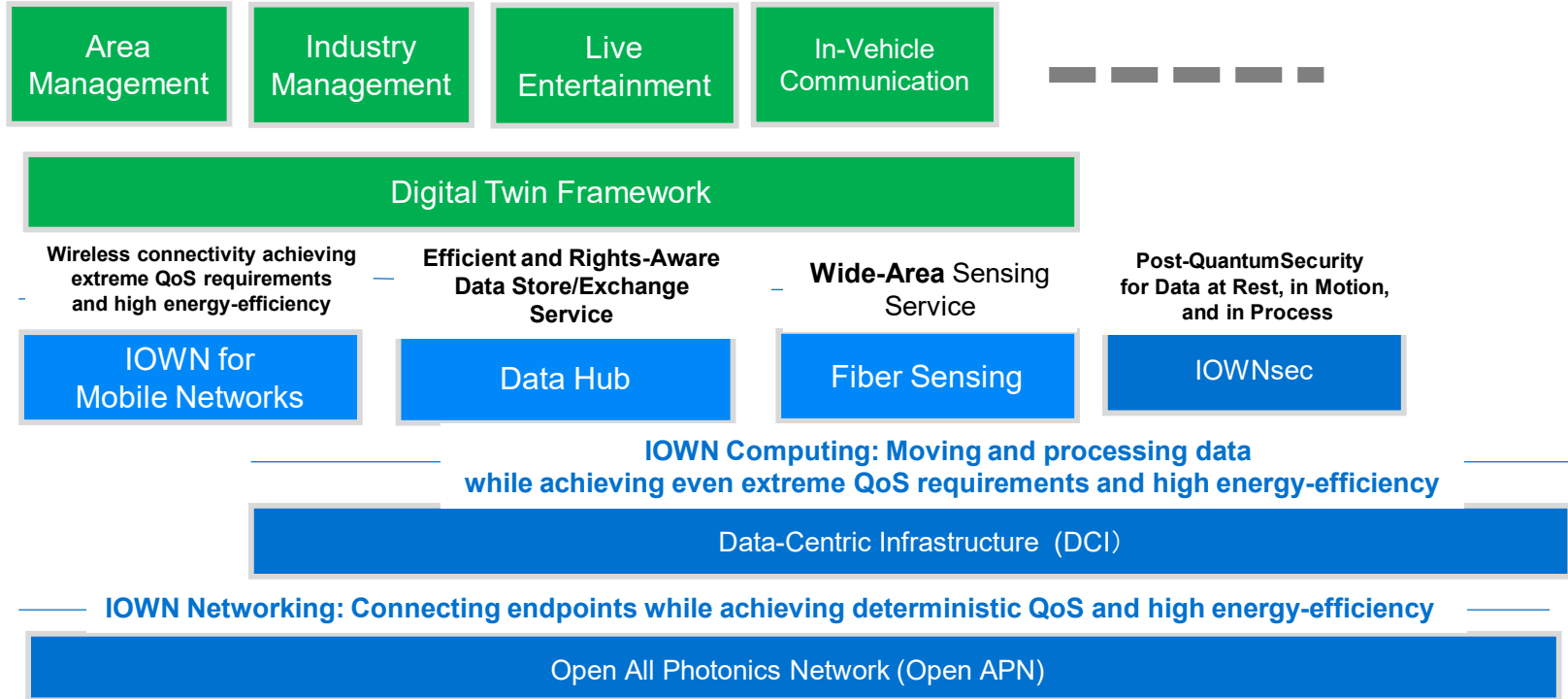

IOWN Global Forum Members

Sponsor Members

Accenture Japan	Furukawa Electric	NEC	Samsung Electronics
Chunghwa Telecom	HAKUHODO	NICT	SK Hynix
Ciena	Intel	Nokia	SK Telecom
Cisco Systems	KDDI	NTT	Sony Group
Dell Technologies	KIOXIA	Oracle Japan	Sumitomo Electric Industries
Deloitte Tohmatsumu	Microsoft	ORANGE	Toyota Motor
Delta Electronics	Mitsubishi Electric	PwC Japan	VMware
Ericsson	Mizuho Bank	Rakuten Mobile	
Fujitsu	MUFG Bank	Red Hat	

General Members

Accton Technology	Hewlett-Packard Japan	Mitsubishi Research Institute	RICOH
AISIN	Hitachi	Mitsui Knowledge Industry	Santec
ADVANTEST	HONDA TSUSHIN KOGYO	Murata Manufacturing	SCSK
AGC	I-PEX	NetApp	SENKO Advanced Components
AIOCORE	IBIDEN	Net One Systems	Shin-Etsu Chemical
AJINOMOTO	Infinera	NIPPON STEEL Chemical & Material	SHINKO ELECTRIC INDUSTRIES
ANRITSU	IP Infusion	NISSHO ELECTRONICS	SKY Perfect JSAT
Avago Technologies	ITOCHU Techno-Solutions	Nissan Chemical	SUMITOMO BAKELITE
CommScope	JGC Japan	Nitto Boseki	Sumitomo Corporation Kyushu
Dai Nippon Printing	JSR	NVIDIA	TELEFÓNICA
Dentsu Group	Juniper Networks	OKI Electric Industry	Toppan
DIC	JX Nippon Mining & Metals	Olympus	Toshiba
DriveNets	Keysight Technologies	OPTAGE	Toyo Ink SC Holdings
e-solutions	MIRAIT	Peers	UNIADDEX
EXEO Group	MIRISE Technologies	Preferred Networks	Wistron
Fujikura	Mitsubishi Corporation	ProteanTecs	Yazaki
HAKUSAN	Mitsubishi Chemical	Qualcomm	
HAZAMA ANDO	Mitsubishi Heavy Industries	Renesas Electronics	

Academic or Research Members

The National Institute of Advanced Industrial Science and Technology (AIST)	National Research Institute for Earth Science and Disaster Resilience (NIED)
Central Research Institute of Electric Power Industry (CRIEPI)	Osaka University
Cloud Computing & IoT Association in Taiwan (CIAT)	Photonics Electronics Technology Research Association (PETRA)
Hiroshima University	Photonics Industry & Technology Development Association (PIDA)
Institute for Information Industry(III)	SBI Graduate School
Industrial Technology Research Institute (ITRI)	Taiwan Association of Information and Communication Standards (TAICS)
Japan Aerospace Exploration Agency (JAXA)	Tohoku University
Keio University	The University of Tokyo
National Institute of Informatics (NII)	

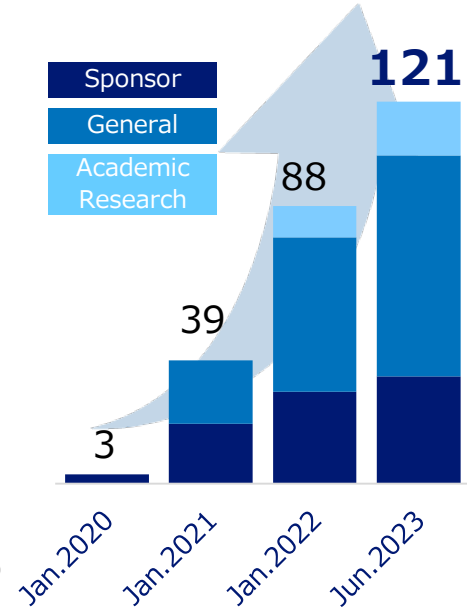

As of June 2, 2023